

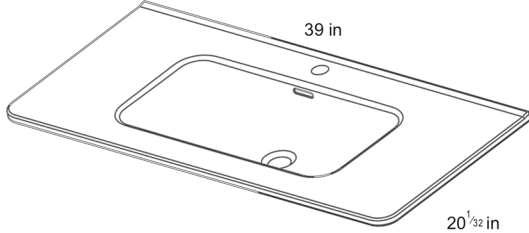







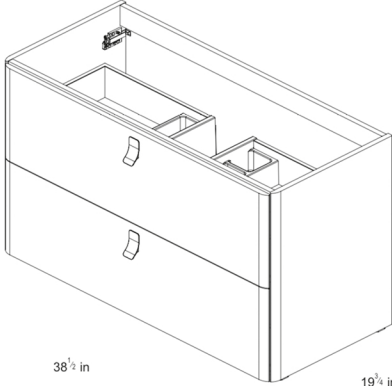

Technical features

Technical drawing	Name	Material	Colour	Ref.
	BEAUTY			Gloss White

	CONCERT 2 Drawers			Nordic Oak
				Samara Ash
				Gloss White

	LEGS		Chrome
---	-------------	---	--------

Technical information

STRUCTURE	MDF board in 5/8 in. continuous wrapping in 2D / Cyclum Process.
FRONT	MDF board in 5/8 in. continuous wrapping in 2D / Cyclum Process.
HANDLE	Metallic bright chrome finish.
DRAWER	Drawers made in mokka textile poly laminate coated board with hidden partial extraction runners with soft close system. Lower drawer useful space (width x height x depth): 27 ^{5/16} x 4 ^{5/16} x 12 ^{3/4} in.
WALL HANGING BRACKET	Hidden hanging bracket of directly assembled with great resistance and depth regulations.
LEGS	Metallic in bright chrome finish. (optional)
PIPE DEPTH	Pipe depth 2 ^{3/4} in.

Collection Concert	Model Concert 100	Dimensions Metric 1 inch = 2.54 cm 1 inch = 25.4 mm	 1051 Lea Drive - Collegeville, PA 19426 Tel. 215 513 9400 - Fax 610 831 0215 www.ws bathcollections.com - info@ws bathcollections.com
-----------------------	------------------------	---	---

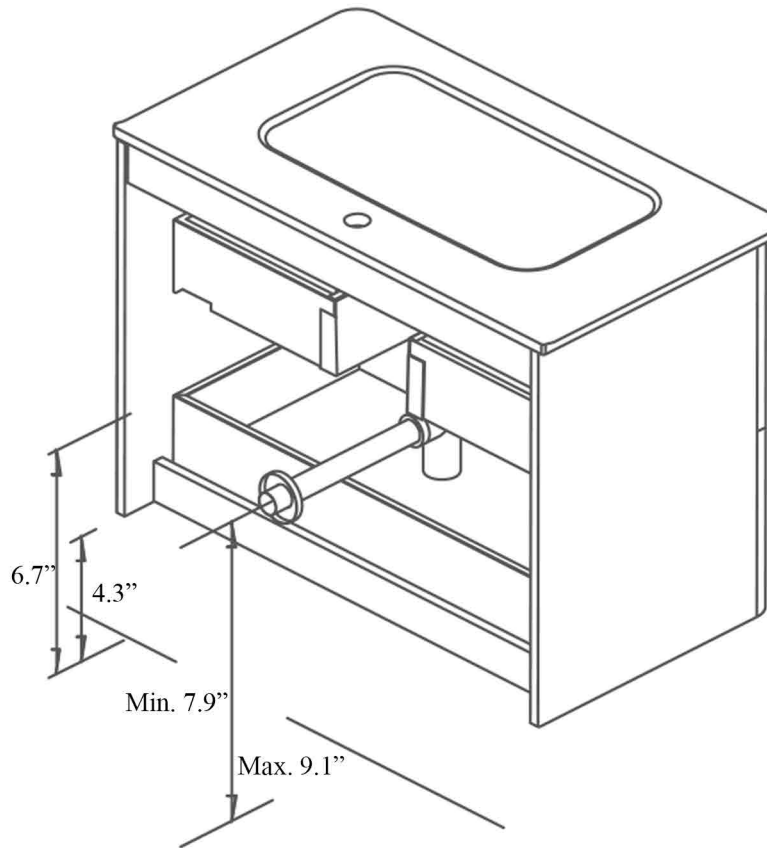

ES

EN

Las cotas indicadas en los dibujos son en función de la altura de la pata del conjunto, en caso de que el mueble vaya suspendido y esta altura no se respete, dichas cotas también variarán.

Dimensions indicated in the drawing are based on the level of the whole leg, in case of wall hanging the furniture dimensions also may vary.

Collection
Concert

Model
Concert 100

Dimensions Metric

1 inch = 2.54 cm
1 inch = 25.4 mm



1051 Lea Drive - Collegetown, PA 19426
Tel. 215 513 9400 - Fax 610 831 0215
www.ws bathcollections.com - info@ws bathcollections.com

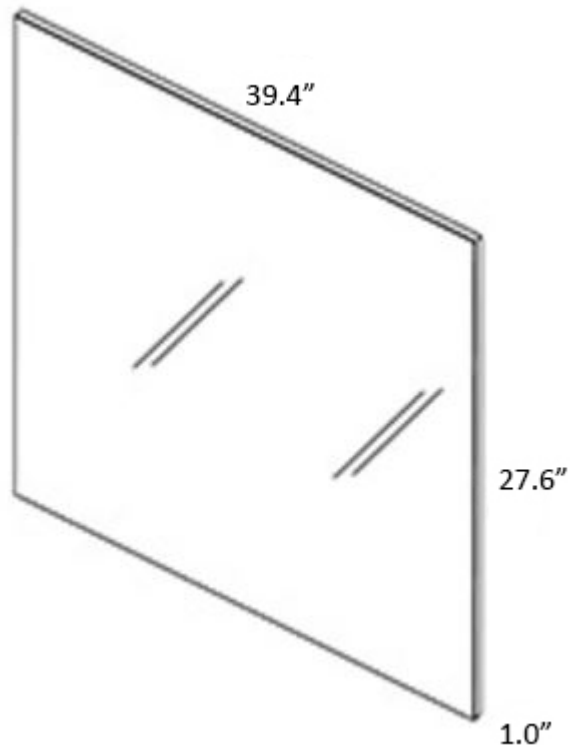

Collection
Murano

Model |
Murano 100

Dimensions Metric

1 inch = 2.54 cm
1 inch = 25.4 mm







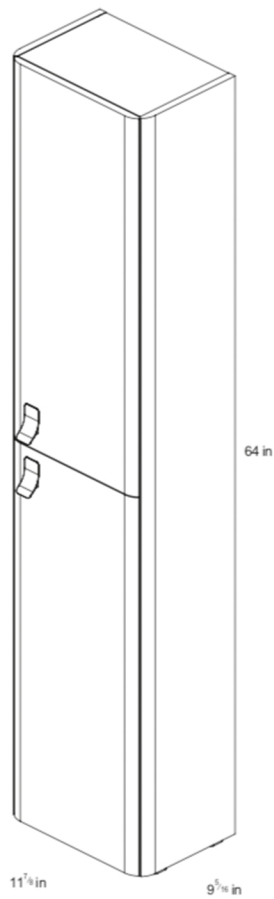

WS[®]
BATH
COLLECTIONS

1051 Lea Drive - Collegeville, PA 19426
Tel. 215 513 9400 - Fax 610 831 0215

www.ws bathcollections.com - info@ws bathcollections.com

Technical features / Características técnicas



Name Nombre	Material Material	Colour Color	Ref.
			Nordic Oak
CONCERT 2 Doors 2 Puertas	  		Samara Ash
			Gloss White

Technical information / Información técnica

STRUCTURE	MDF board in 58 in. continous wrapping in 2D/ Cyclum Process.
FRONT	MDF board in 58 in. continous wrapping in 2D/ Cyclum Process.
HANDLE	Metallic bright chrome finish.
INTERNAL DISRTIBUTION	2 mobile wooden shelves and 1 fixed wooden shelf.
HINGE	105° opening, Ø1 3/8 in. cap, easy assembly and soft close system.

Collection
Concert

Model |
Concert Column

Dimensions Metric
1 inch = 2.54 cm
1 inch = 25.4 mm

WS®
BATH
COLLECTIONS
1051 Lea Drive - Collegeville, PA 19426
Tel. 215 513 9400 - Fax 610 831 0215
www.wsbathcollections.com - info@wsbathcollections.com

We recommend the following items that work with your sink.

TRAPS



WSBC 53922
Our best seller

DRAINS



WSBC 53991
Push waste drain (click clack)
with overflow

MOUNTING HARDWARE

Wall-mount installation



Bolts

Vessel/ countertop installation



Silicone (*optional*)

Collection
Concert

Model |
Concert 100

Dimensions Metric
1 inch = 2.54 cm
1 inch = 25.4 mm

WS®
BATH
COLLECTIONS

1051 Lea Drive - Collegeville, PA 19426
Tel. 215 513 9400 - Fax 610 831 0215

www.ws bathcollections.com - info@ws bathcollections.com